

Varenummer: 20146B40652BL
 Beskrivelse: E+G
 Flange rørholder GN 146-B40-65-2-BL

Mål

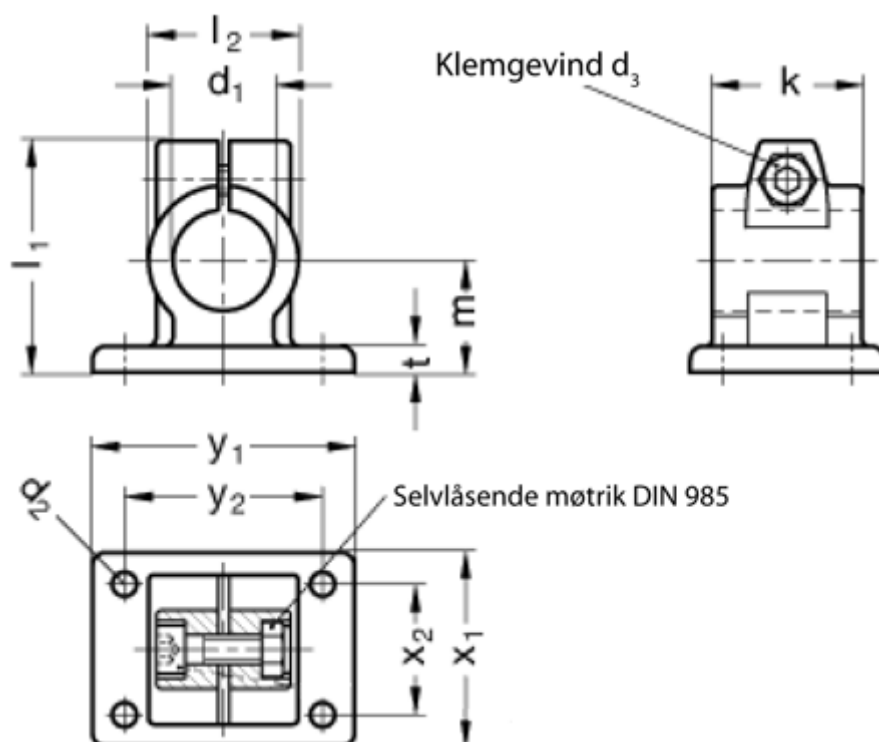

$d_1 = B40$	Vippehåndtag = GN 911-M10-55 skal bestilles separat
$d_2 = 11.0$	$x_1 = 92$
$d_3 = M10$	$x_2 = 62$
$k = 65$	$y_1 = 128$
$l_1 = 95$	$y_2 = 98$
$l_2 = 65$	
$m = 50$	
$t = 14$	